

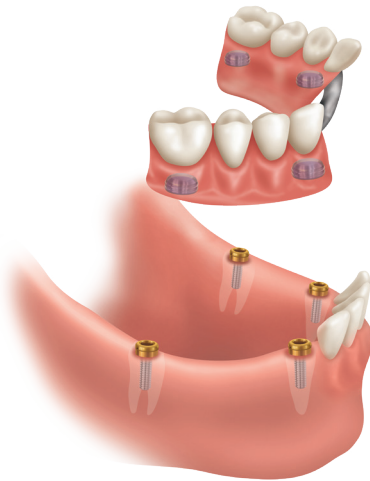

# LOCATOR® ROOT ATTACHMENT SYSTEM TECHNIQUE MANUAL



# TABLE OF CONTENTS

---

1	THE LOCATOR® COMPONENT REFERENCE LIST
2	LOCATOR -ROOT ATTACHMENT SYSTEM
3	LOCATOR - A FAMILY OF SOLUTIONS
4	LOCATOR STANDARD AND EXTENDED RANGE MALES
5	LOCATOR 3-IN-1 CORE TOOL
6	LOCATOR ROOT ATTACHMENT SYSTEM
6	6 Placement of a LOCATOR Root Abutment
9	9 Cast-To Coping
10	PROCESSING LOCATOR DENTURE CAPS INTO THE OVERDENTURE
10	10 Direct Technique
13	13 Indirect Technique
16	MAINTENANCE OF THE LOCATOR ABUTMENT
16	16 Reline of Implant-Retained and Tissue Supported Overdentures
19	OVERDENTURE INSERTION, REMOVAL AND CLEANING GUIDELINES
19	19 For the Clinician and Patient
20	RETURN POLICY AND WARRANTY

**PLEASE NOTE:** This document is designed to serve as a guide for dental clinicians using Zest Dental Solutions® Products. It is not intended to be a substitute for professional training and experience. Please refer to the Instructions For Use for further information.

# THE LOCATOR® COMPONENT REFERENCE LIST

## LOCATOR ROOT ABUTMENTS

### ROOT ABUTMENTS



## LAB PROCESSING

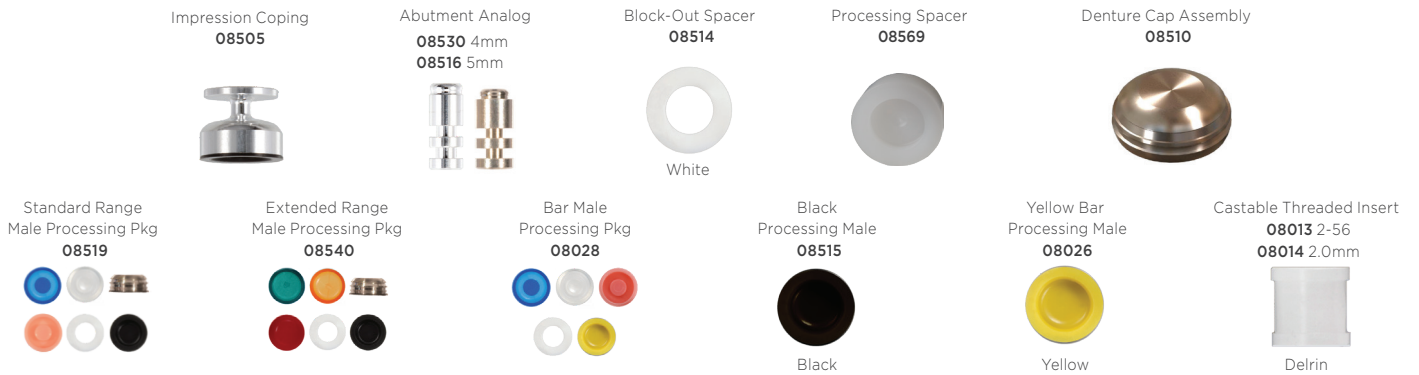

## REPLACEMENT MALES

### STANDARD RANGE



### EXTENDED RANGE

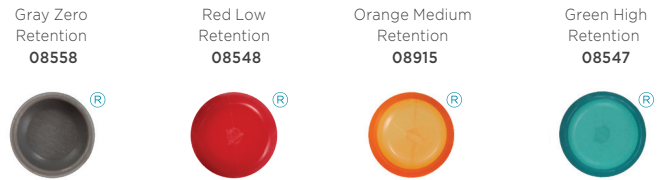

## DRILLS & TAPS



## TORQUE DRIVERS & TOOLS

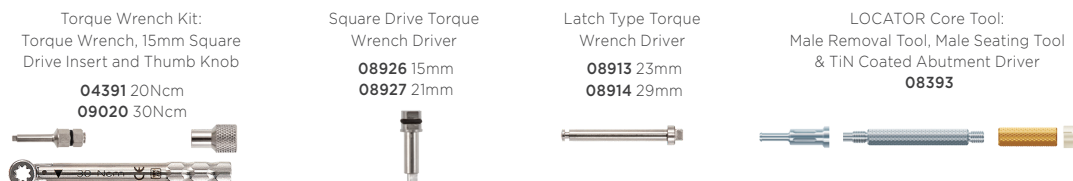

# The **LOCATOR® Root Attachment System** leverages the natural tooth root for the retention of overdentures or removable partial dentures.

---

For patients who have financial limitations or are unwilling to move forward with traditional implant treatment for other reasons, LOCATOR Root can provide the emotional and health benefits of retention, esthetics and stability vs. traditional dentures or partial dentures with clasps.

Using the natural tooth root for retention gives the patient better outcomes and time to prepare for the cost and procedure of dental implants in the future.

Retaining the natural tooth root can also help the emotional transition into implants and deter further bone loss; thus, helping to maintain facial structure and ensuring future implants are placed more successfully.

**LOCATOR Root Attachments** give you the choice of a straight post and two angles (10 and 20 degrees) to accommodate divergent roots. A cast-to version is also available for telescopic copings, partial or full dentures.

## **LOCATOR® Root: Immediate Retention While Implants Integrate**

Utilize the patient's natural tooth root for retention while the implants are integrating. Once the implants are integrated, extract the teeth and load the implants. Give your patients the performance and confidence they deserve sooner!

**LOCATOR Root for Removable Partials** stabilizes a prosthesis without the use of metal clasps for improved esthetics and retention and preserves the health of remaining teeth.

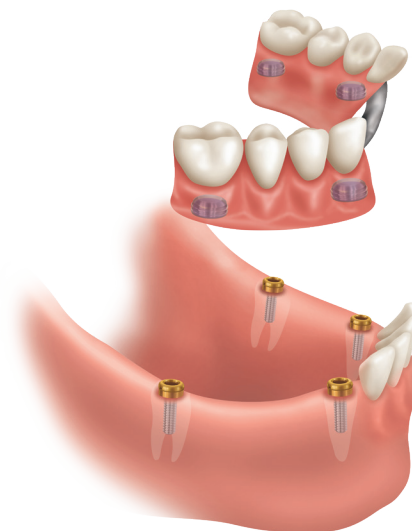
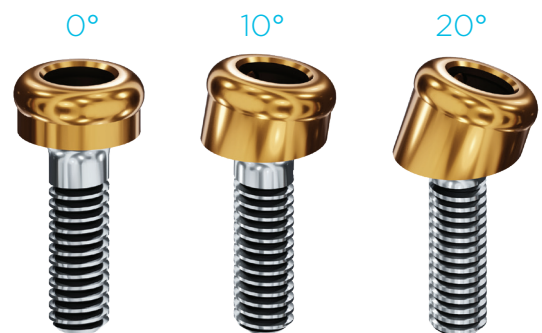



# LOCATOR® - A FAMILY OF SOLUTIONS

---

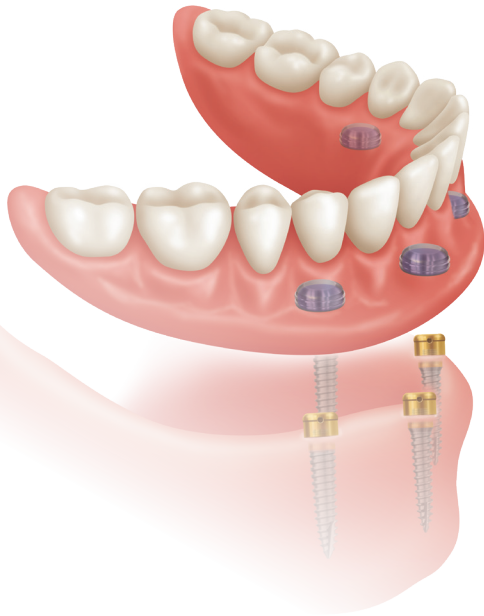

## Implant Attachment

The LOCATOR Implant Attachment with patented pivoting technology is the premier system for implant-retained overdentures. According to recent studies<sup>1</sup>, a two implant-retained, tissue-supported overdenture restoration is considered the minimum standard of care for edentulous patients. More than two implants may also be placed for an implant-retained overdenture.

## Bar Attachment

When a case calls for an overdenture bar, the LOCATOR Bar Attachment provides the same pivoting technology, self-aligning feature, superb retention, and exceptional durability, all in a low-profile design. It also offers three options for the fabrication of a resilient attachment on an implant-supported cast alloy or milled titanium bar.

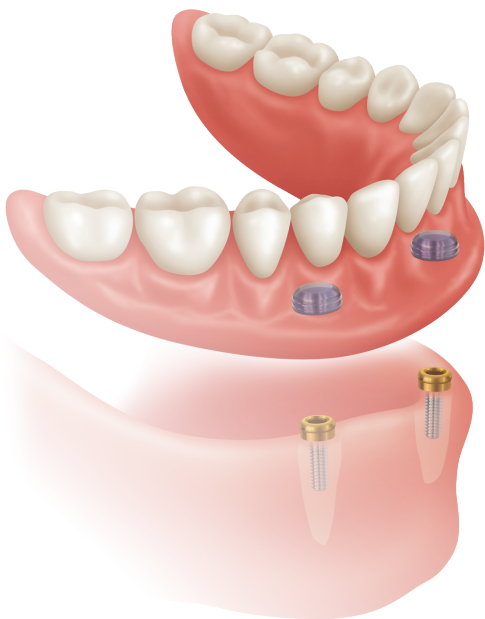
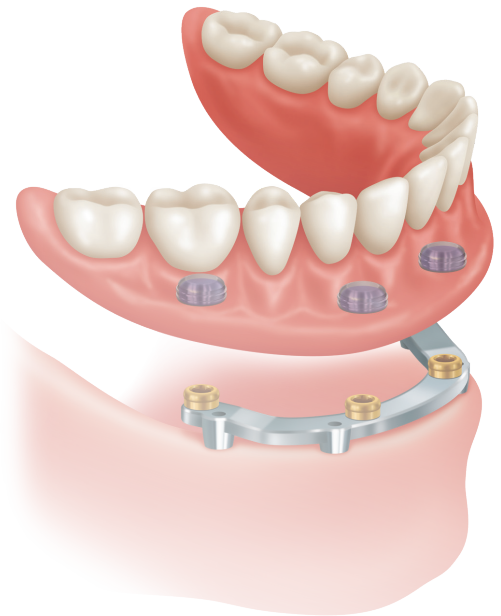

## Root Attachment

In clinical situations where healthy tooth roots can be prepared for placement of attachments to retain an overdenture, the LOCATOR Root Attachment delivers great versatility. Its supra-radicular design gives you the choice of a straight post, 10° and 20° angles to accommodate divergent roots, as well as a special cast-to version.

<sup>1</sup>Source: Journal of Dental Implants

# LOCATOR® STANDARD AND EXTENDED RANGE MALES

The magic is in the pivot, it allows for a resilient connection of the prosthesis and prevents damage to Males during insertion.

## STANDARD MALES

Dual retention to maximize stability and pivoting action that accommodates up to 20° divergence between two implants.

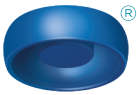

Blue Low Retention



Pink Medium Retention



Clear High Retention

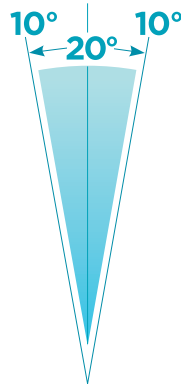

## EXTENDED RANGE MALES

Pivoting action accommodates up to 40° of total divergence between two implants.



Gray Zero Retention



Red Low Retention



Orange Medium Retention

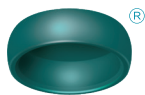

Green High Retention

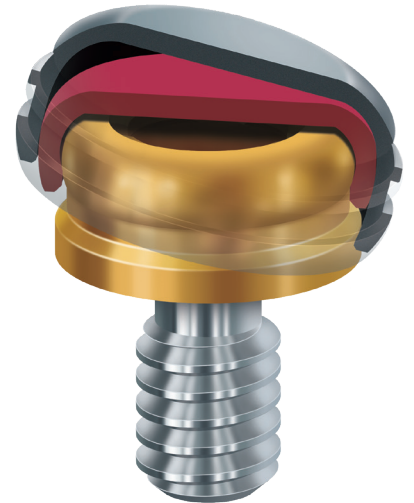
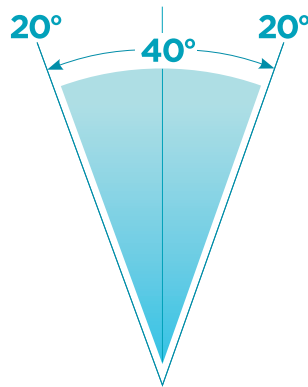

# LOCATOR® 3-IN-1 CORE TOOL

This convenient tool is used to carry the LOCATOR Abutment, remove the LOCATOR Male and insert the Male into the LOCATOR Denture Cap. In order to achieve 30Ncm of torque, the Abutment Driver portion of the tool is compatible with various types of restorative drivers.

## REMOVAL TOOL

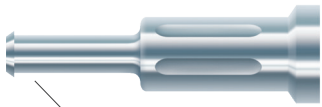

1

### REMOVAL

The Removal Tool has a sharp edge on the end to engage and remove the Male from the Denture Cap.

## INSERTION TOOL

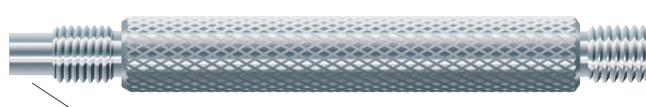

2

### INSERTION

The Insertion Tool is used to seat the LOCATOR Male.

## ABUTMENT DRIVER & SLEEVE



3

### PLACEMENT

The LOCATOR Abutment Driver with the Abutment Holder Sleeve carries the Abutment securely and places it onto the implant.

Loosen the Removal Tool a full 3 turns counter clockwise (you will see a visible gap).

To remove a LOCATOR Male from the Denture Cap, simply insert the tip into the Cap/Male assembly and push straight into the bottom of the Male. Then, tilt the tool so that the sharp edge of the tip will grab hold of the Male and pull it out of the Denture Cap.

To disengage the Male from the tip of the Removal Tool; point the tool down and away from you and tighten the Removal Tool clockwise back onto the Core Tool. This will activate the removal pin and disengage the Male from the tip of the Removal Tool.

Separate the Removal Tool section from the LOCATOR Core Tool and use the Seating Tool end to place a new Male into the empty Denture Cap.

NOTE THE GAP ONCE TURNED COUNTER CLOCKWISE

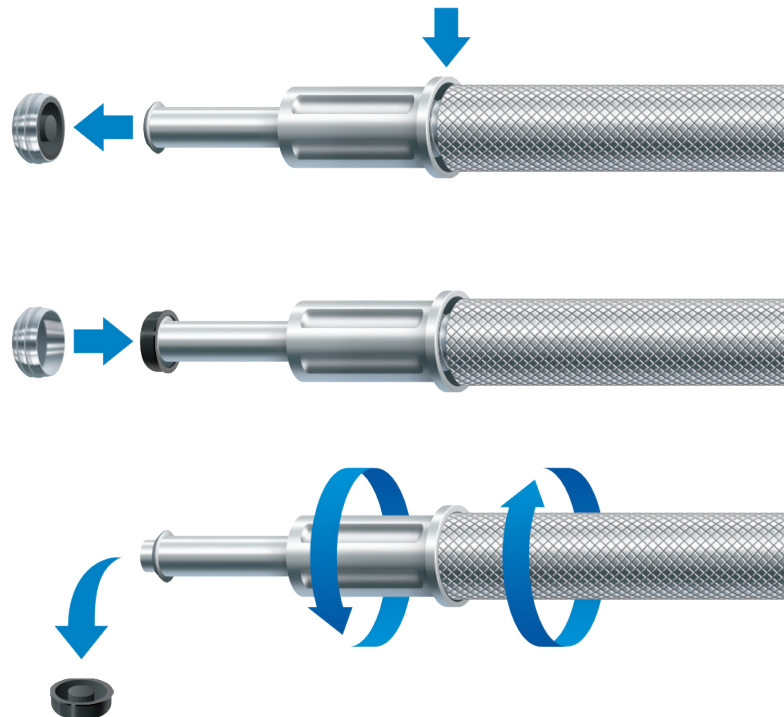

# LOCATOR® ROOT ATTACHMENT SYSTEM

## PLACEMENT OF A LOCATOR ROOT ABUTMENT

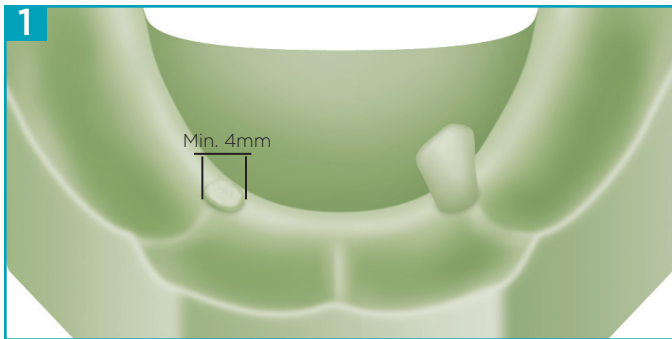

**1** Take an impression of the arch and pour a diagnostic model. Reduce the teeth to 1mm above the gingival tissue and measure the root width to determine the space available for a LOCATOR Root Abutment.

**NOTE:** The width of the root surface must equal or exceed 4mm.

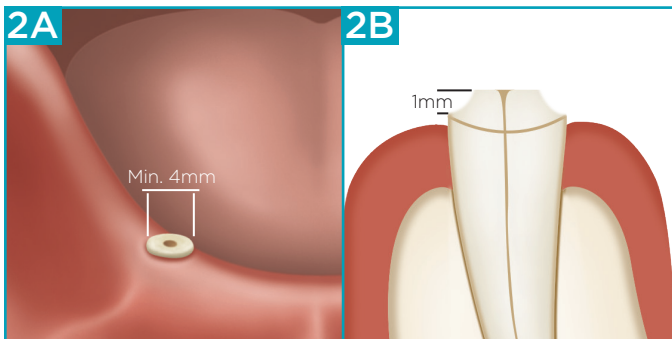

**2A-2B** Radiograph the tooth roots to measure and determine the proper angle of post on the LOCATOR Abutment. Decoronate the root and perform endodontic therapy. Remove the desired depth of gutta percha following standard clinical procedures. Finish contouring of the roots. The final reduction should place the root surface 1mm supragingival.

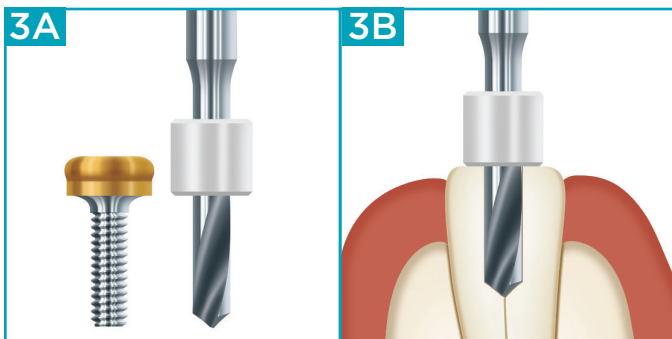

**3A-3B** Hold the LOCATOR Abutment next to the Pilot Drill and set the plastic Depth Reference Ring on the Pilot Drill to match the screw threads length. The screw threads can be shortened if needed. Size the canal using the Pilot Drill stopping at the depth ring. The alignment of this initial preparation will generally follow the canal. On a non-parallel root, the resulting divergence can be corrected using an angled LOCATOR Abutment 10° or 20°.

**CAUTION:** The danger of root perforation exists when the full length of the Pilot Drill is used.

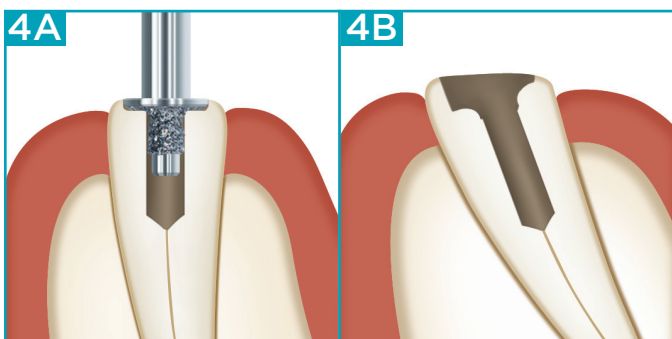

**4A-4B** Spotface the root surface using the Spotface Diamond Bur to a depth where a full 360° recessed seat first appears on the occlusal surface of the root. Create the minimum possible recessed seat on the shallow side of the preparation.

In the event a portion of the original depth from the Pilot Drill canal preparation is lost due to countersinking, re-establish the full depth of the canal preparation with the Pilot Drill using the original Depth Reference Ring Setting.

# LOCATOR® ROOT ATTACHMENT SYSTEM

## PLACEMENT OF A LOCATOR ROOT ABUTMENT (CONTINUED)

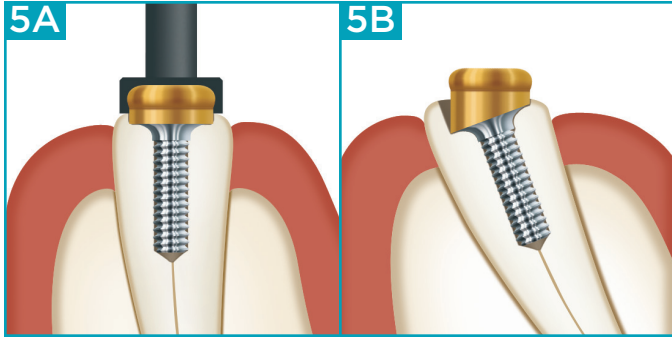

**5A-5B** Place a LOCATOR Parallel Post onto a 0° LOCATOR Root Abutment to act as handle. Place a 0° LOCATOR Root Abutment into each of the prepared roots and verify the proper fit and parallel alignment of multiple Abutments. If the alignment of any of the Abutments can be improved for draw, select the most suitable angled LOCATOR Root Abutment (10° or 20°) and try it into the preparation to determine ideal parallelism.

**NOTE:** Make a small indexing mark on the LOCATOR Root Abutment base and the root surface to return the angled Root LOCATOR to the exact position during cementation.

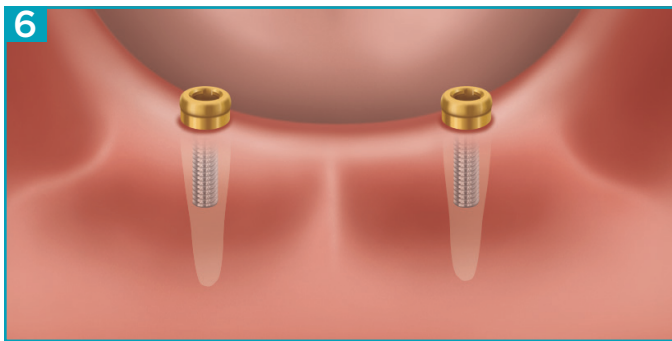

**6** Cement the LOCATOR Root Abutment in place with CEMEZ®. Allow the cement to set. Round off and polish the root surface from the metal flange to the tissue. The Parallel Post can be placed on the LOCATOR Root Abutment to protect it during polishing.



Please refer to page 10 for Direct Pick-Up Techniques.



# LOCATOR® ROOT ATTACHMENT SYSTEM

## CAST-TO COPING

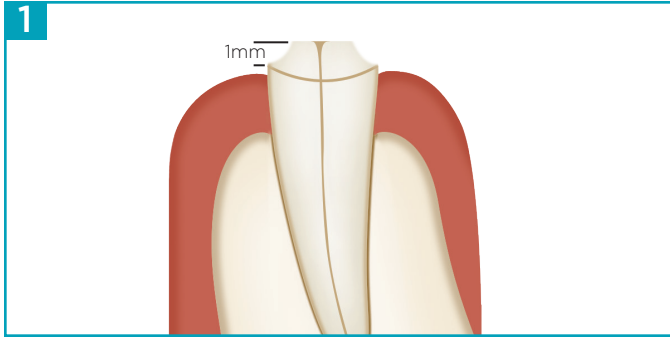

### 1 CAST-TO COPING

Decoronate the root and perform endodontic therapy. Remove the desired depth of gutta percha following standard clinical procedures. Finish the contouring of the root. The final reduction/casting should place the root surface 1mm above gingival tissue. Complete the endodontic treatment and prepare a margin on the tooth utilizing a beveled shoulder or a Chamfer type margin preparation for the custom cast coping to seat on.

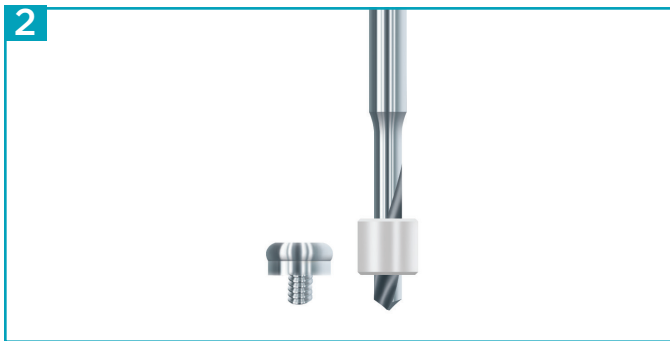

2 Hold the Cast-To LOCATOR Abutment next to the Pilot Drill and set the plastic Depth Reference Ring on the Pilot Drill to a depth that slightly exceeds the Cast-To Coping thread length.

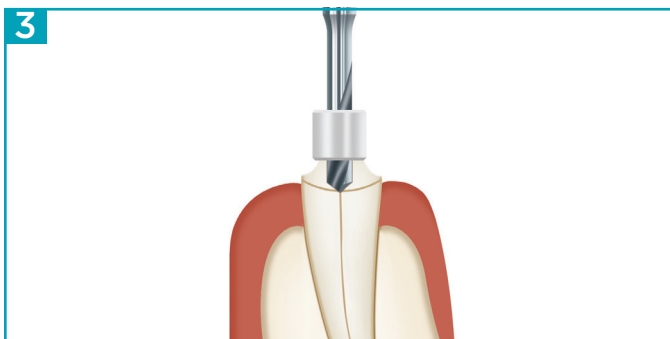

3 Size the canal using the Pilot Drill stopping at the depth ring. The alignment of this initial preparation will generally follow the canal. On a non-parallel root, the resulting divergence can be corrected using an angled LOCATOR Root Abutment (10° or 20°).

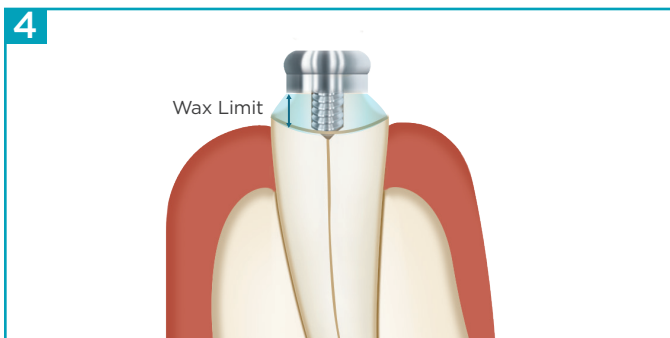

4 Complete the preparation of the site with dental burs of preference to ensure that the cast gold coping will completely surround the LOCATOR Cast-To Abutment.

**NOTE:** The outer surface on the base of the LOCATOR Cast-To Abutment must remain above the level of the coping to allow the Denture Cap to snap on without interference.

Please refer to page 10 for Direct Pick-Up Techniques.

# LOCATOR® ROOT ATTACHMENT SYSTEM

## CAST-TO COPING (CONTINUED)

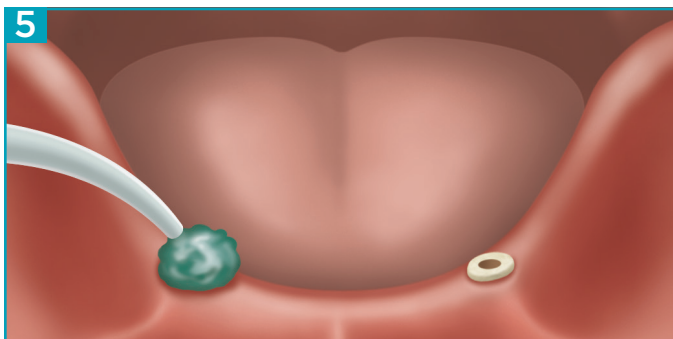

**5** Take an impression of the arch picking up the prepared margins on the tooth and the endodontically treated roots (if needed) and prepare the dies.

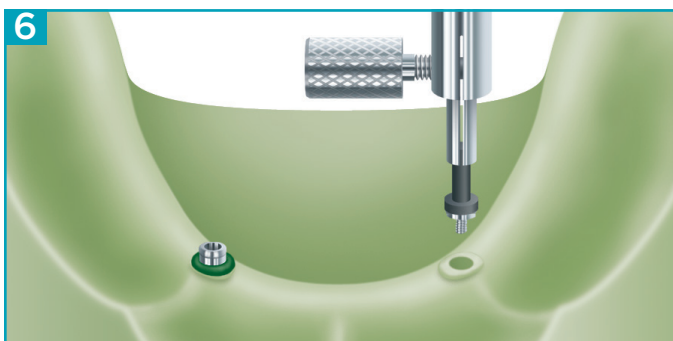

**6** Using a surveyor, place the Parallel Post with the Cast-To LOCATOR Root Abutment attached in position and parallel with other Abutments. Wax the Cast-To LOCATOR Root Abutment directly into the die. Build the wax up to the bottom corner on the base of the Abutment, leaving the majority of the outer surface on the base above the level of the coping. Complete the wax-up process for the coping being sure to pick up all of the marginal interfaces. Remove the wax up from the die and remove the Parallel Post from the Abutment, leaving the top of the Abutment open for investment material to flow into.

Invest and cast. Finish and polish the surface of the coping. The Parallel Post can be placed on the LOCATOR to protect it while polishing.

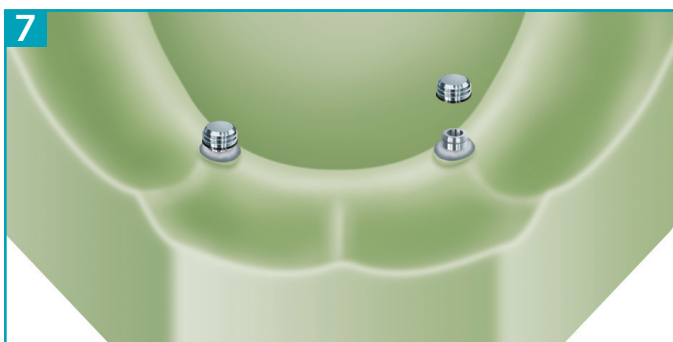

**7** Snap a Denture Cap with a Black Processing Male onto each LOCATOR Analog and verify that there is no interference with the Denture Cap seating.

Proceed with the fabrication of the prosthesis.

Please refer to page 10 for Direct Pick-Up Techniques.



# PROCESSING LOCATOR® DENTURE CAPS INTO THE OVERDENTURE, DIRECT TECHNIQUE

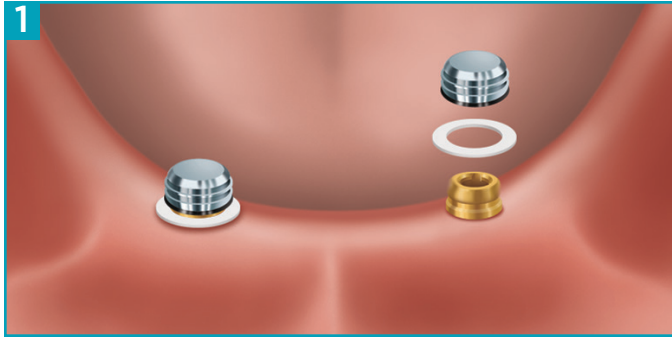

## DIRECT TECHNIQUE FOR NEW OR EXISTING DENTURE

**1** Place a White Block-Out Spacer around each Abutment and press it down to the tissue. Snap a Denture Cap with a pre-loaded Black Processing Male onto each Abutment, pressing down firmly.

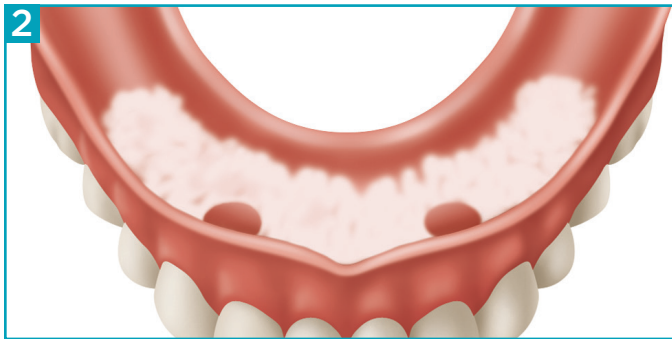

**2** Apply fit check marking paste to the intaglio surface of the overdenture. Insert it into the mouth in position over the Denture Cap. This will mark areas where the overdenture will need to be relieved to allow space for the Caps to be picked up.

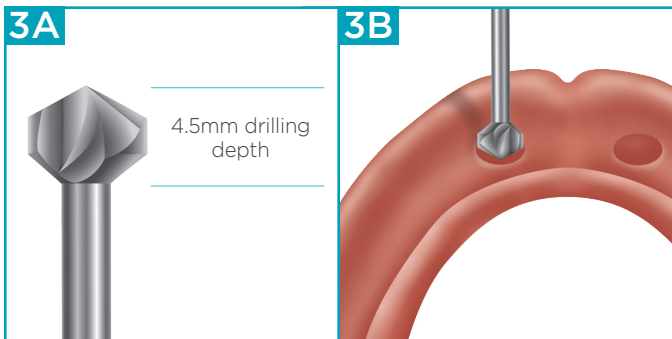

**3A-3B** Relieve the marked areas with the CHAIRSIDE® Recess Bur. Zest recommends using slight pressure and a small rocking motion to get the tip of the Bur started, followed by a straight downward motion to create the desired recess site. This efficient Bur has distinct depth landmarks which indicate where to stop when drilling for the Denture Cap.

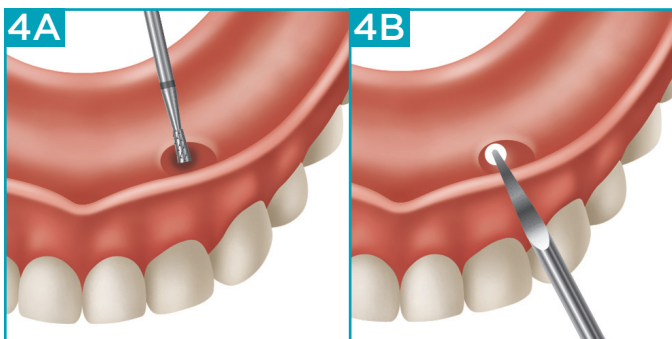

**4A-4B** Use the CHAIRSIDE Undercut Bur to cut an undercut around the circumference of the recesses for mechanical retention. Cut lingual/palatal vent windows in the overdenture with the CHAIRSIDE Vent Bur to visualize full seating and for excess material to vent.

# PROCESSING LOCATOR® DENTURE CAPS INTO THE OVERDENTURE, DIRECT TECHNIQUE (CONTINUED)

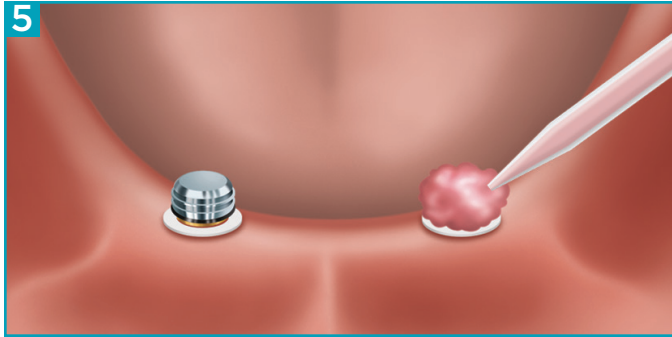

**5** Dry the Denture Caps. Apply a small amount of CHAIRSIDE® Attachment Processing Material around the circumference of each Cap. Place CHAIRSIDE Material into the recesses in the overdenture and seat it over the Caps and onto the tissue. Have the patient close into light occlusion and hold while the CHAIRSIDE Material sets. Please refer to CHAIRSIDE Attachment Processing Material IFU for set times.

**NOTE:** Excessive occlusal pressure during the setting time may cause tissue recoil against the overdenture base and could contribute to dislodging and premature wear of the Males.

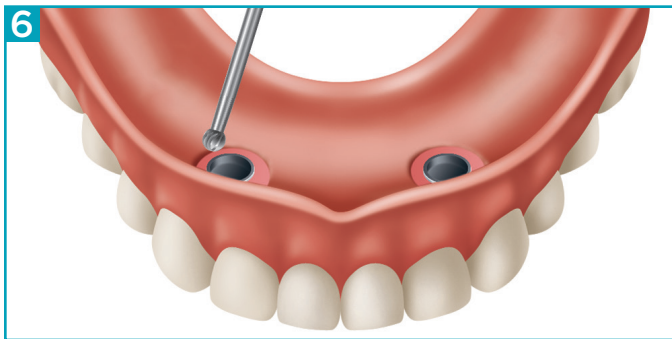

**6** Disengage the overdenture from the Abutments and remove from the mouth. Verify that the Denture Caps have been securely processed into the overdenture. Fill any voids and light cure. The material will bond to itself and will cure within 30 seconds with light application. Remove any excess material with the CHAIRSIDE Grind Bur.

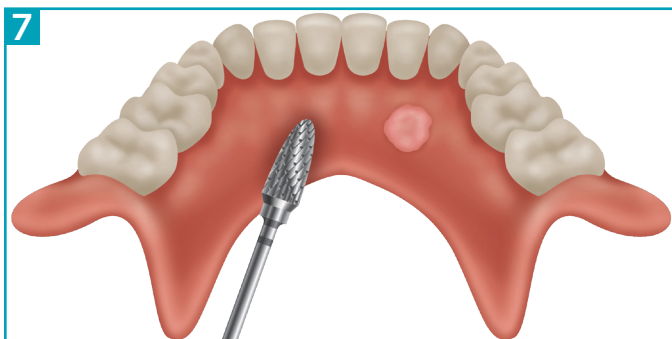

**7** Use the CHAIRSIDE Trim Bur to remove any excess acrylic material remaining on the overdenture.

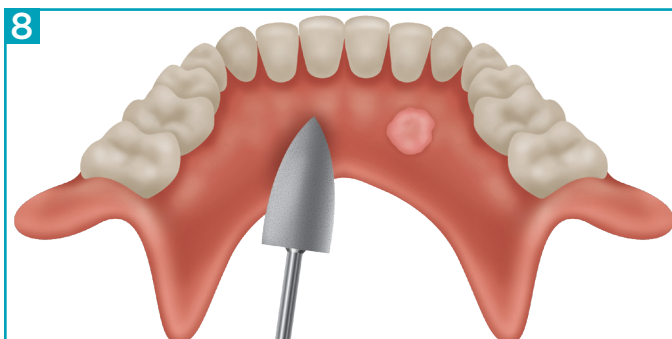

**8** Use the CHAIRSIDE Polish Bur to create a smooth finish of the overdenture.

# PROCESSING LOCATOR® DENTURE CAPS INTO THE OVERDENTURE, DIRECT TECHNIQUE (CONTINUED)

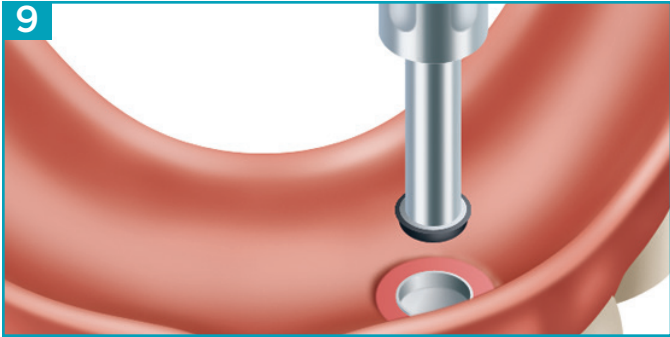

**9** Remove the Black Processing Male using the Removal Tool.

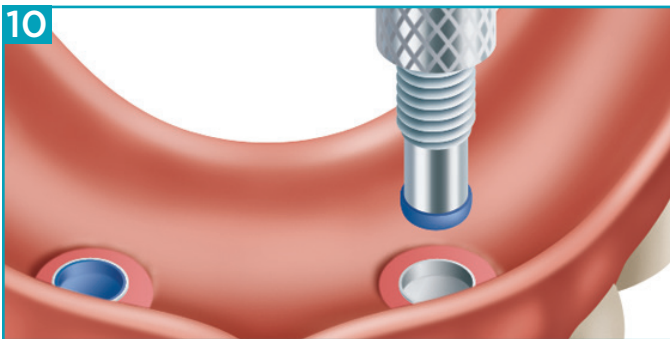

**10** Place the selected final Male into each Denture Cap using the Insertion Tool. Start with the least retentive Male for the initial patient try-in.

**NOTE:** Please refer to the LOCATOR 3-In-1 Core Tool instructions on page 5.

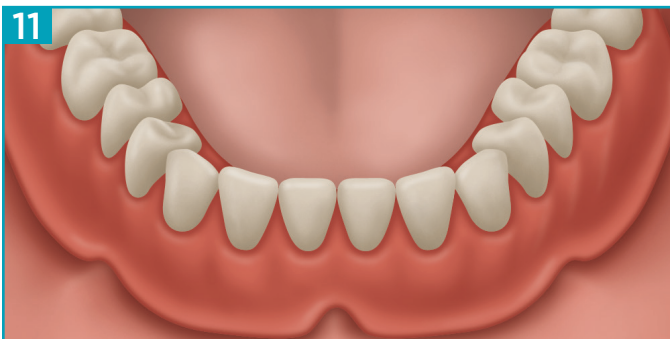

**11** Seat the overdenture and press down to engage the Males on the LOCATOR Abutments and verify the occlusion. Instruct the patient on how to remove and insert the overdenture. If the retention is not satisfactory, remove the Males and replace with the next level of retention.

**NOTE:** Refer to the Standard and Extended Range Males retention chart on page 4. Please refer to page 19 for instructions on proper home care maintenance and required recall visits.

# PROCESSING LOCATOR® DENTURE CAPS INTO THE OVERDENTURE, INDIRECT TECHNIQUE



## INDIRECT TECHNIQUE/LABORATORY PROCESSING

**1** A stock or custom impression tray may be used. Ensure that each recess has enough space for the height of the LOCATOR Impression Copings.

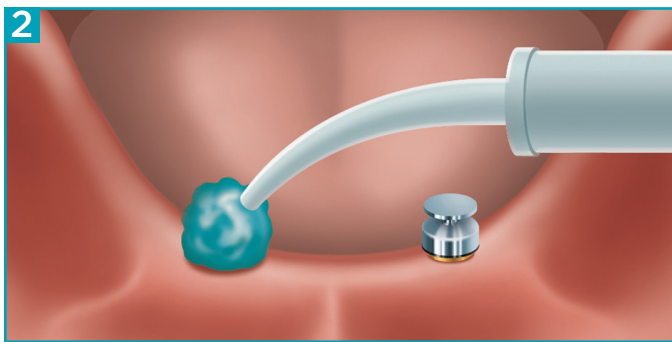

**2** Place a LOCATOR Impression Coping on each Abutment and press down firmly. Syringe CHAIRSIDE® Medium Body Impression Material, around the circumference of each coping. Fill the impression tray and insert it over the copings and onto the tissue. Allow the material to set and remove the Impression Tray.

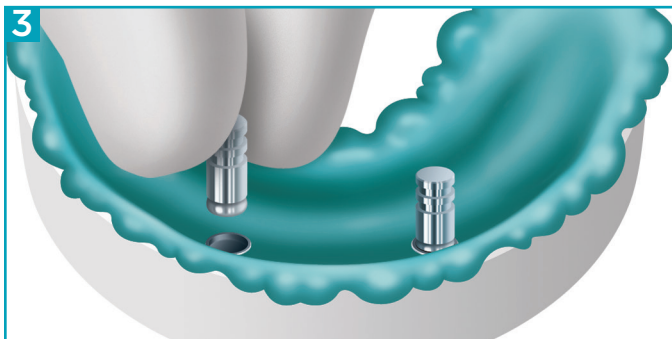

**3** Seat the appropriate diameter LOCATOR Analogs into each Impression Coping and send the impression to the laboratory.

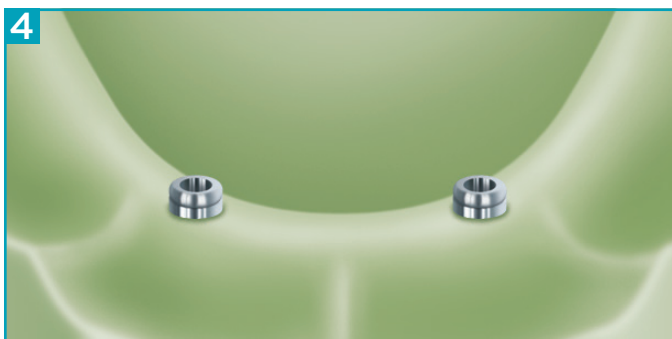

**4** Verify that the Analogs are secure in the Impression Copings and pour a model.



# PROCESSING LOCATOR® DENTURE CAPS INTO THE OVERDENTURE, INDIRECT TECHNIQUE (CONTINUED)

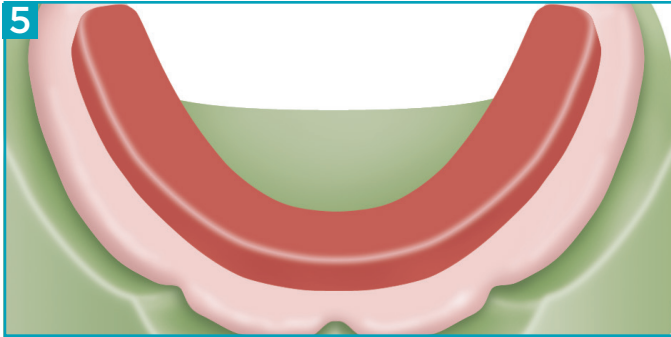

**5** Fabricate the baseplate and wax rim on the cast for the bite registration. The Denture Caps with Black Processing Males may be processed into the baseplate to provide stabilization during record making and try-in.

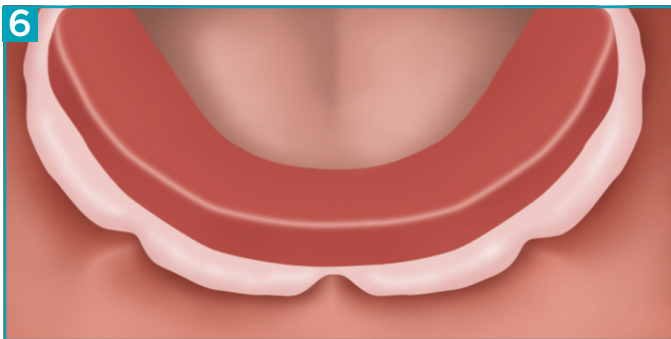

## **6** BITE RECORDS

Place the bite block into the mouth and record the jaw relation. Take an impression of the opposing arch and pour the cast. Select a shade for the overdenture teeth.

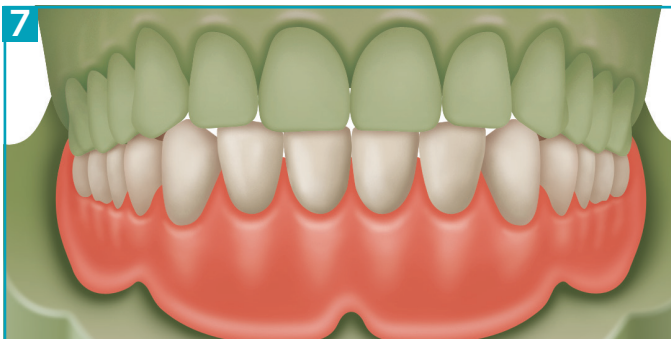

**7** Articulate the models and proceed with the overdenture teeth set up.

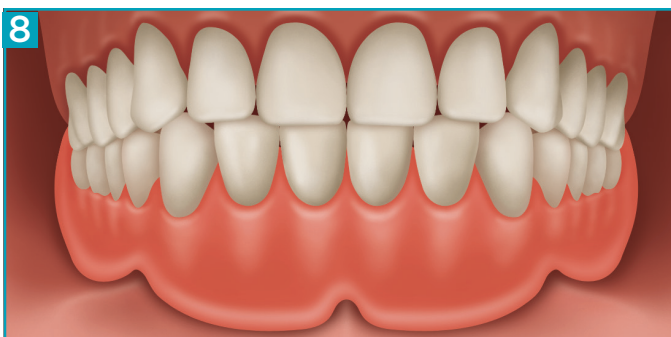

## **8** OVERDENTURE TRY-IN

Place the try-in overdenture into the mouth and verify the fit, attachment engagement, esthetics, phonetics and occlusion.

# PROCESSING LOCATOR® DENTURE CAPS INTO THE OVERDENTURE, INDIRECT TECHNIQUE (CONTINUED)

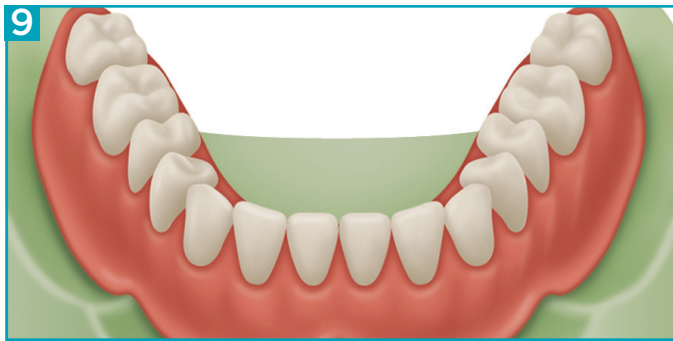

**9** Finalize and flask the overdenture for processing. Separate the flask and boil away all wax. Place the Denture Caps with Black Processing Males on the Analogs and press down firmly. Place the cast back into the flask and verify that there is no contact with the teeth. Close the flask and process the overdenture. Remove the overdenture from the flask, finish, and polish.

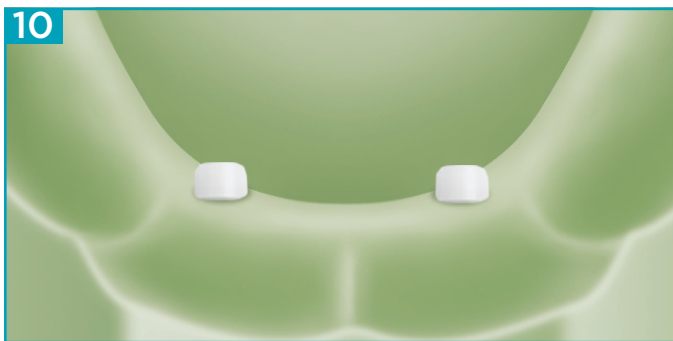

**10** **Optional Step:** A Processing Spacer could be used instead of the Denture Caps during the fabrication of the overdenture if the clinician prefers to pick up the Denture Caps chairside. The Processing Spacer creates a recess in the overdenture to allow for the Denture Cap to be seated without any interference with the surrounding overdenture acrylic.

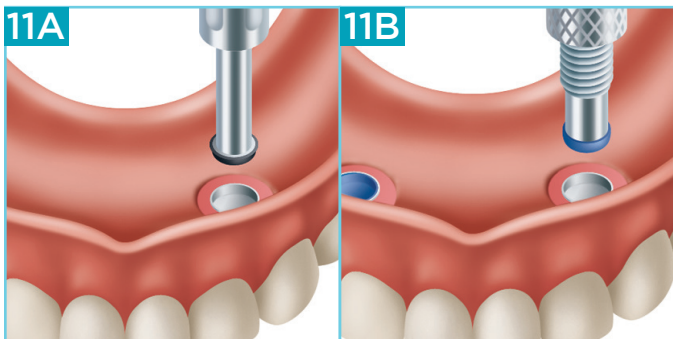

**11A-11B** Remove the Black Processing Male using the Removal Tool. Place the selected final Male into each Denture Cap using the Insertion Tool. Start with the least retentive Male for the initial patient try-in.

**NOTE:** Please refer to the LOCATOR 3-In-1 Core Tool instructions on page 5.

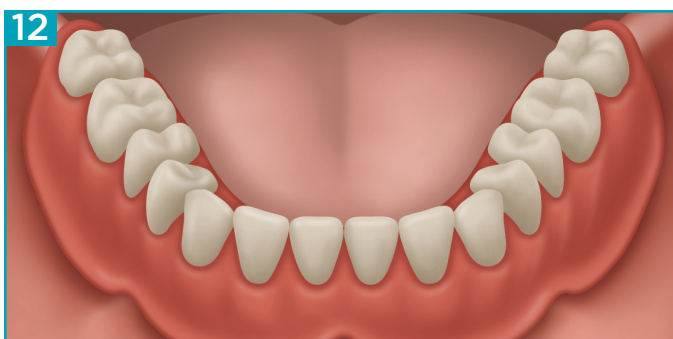

## **12** DELIVERY

Place the overdenture in the mouth and press down to engage the Males on the LOCATOR Abutments. Verify the occlusion. If the retention is not satisfactory, remove the Males and replace with the next level of retention.

**NOTE:** Please refer to the Standard and Extended Range Males chart on page 4 for additional selection criteria. Please refer to page 19 for instructions on proper home care maintenance and required recall visits.

# MAINTENANCE OF THE LOCATOR® ABUTMENT

## RELINE OF IMPLANT-RETAINED AND TISSUE SUPPORTED OVERDENTURES

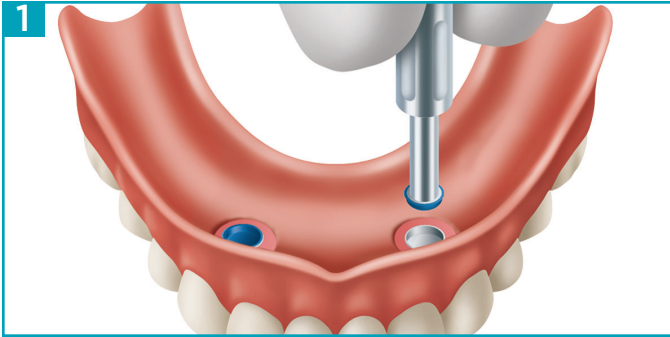

**1** Remove the Males from the overdenture.

**NOTE:** Please refer to the LOCATOR 3-In-1 Core Tool instructions on page 5.

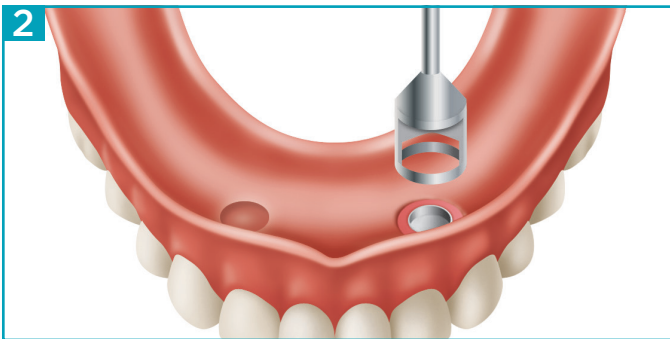

**2** Using a trephine drill, remove the existing Denture Cap from the overdenture.

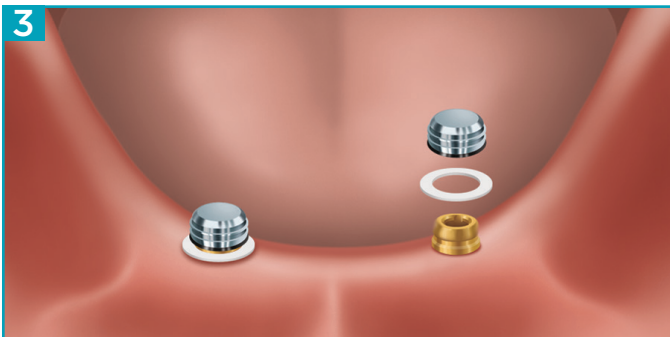

**3** Place a white Block-Out Spacer around each Abutment and press it down to the tissue. Snap a new Denture Cap with a pre-loaded Black Processing Male onto each Abutment, pressing down firmly. Try in the overdenture to ensure each recess is large enough to accommodate the new Denture Cap with no interference with the acrylic.

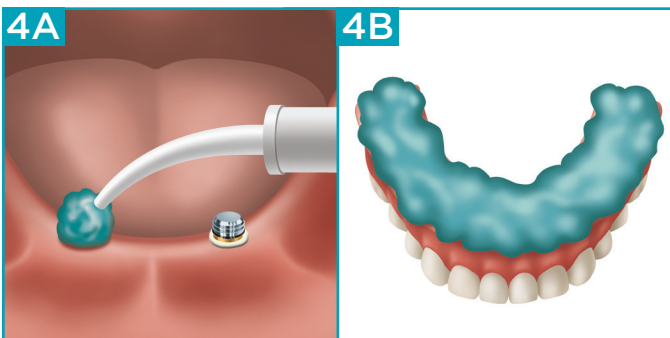

**4A-4B** Apply an adhesive to the intaglio surface of the overdenture and take an impression using the overdenture as a tray. Place the overdenture into the mouth. Have the patient close into the light occlusion and hold. Allow the impression material to set.



# MAINTENANCE OF THE LOCATOR® ABUTMENT

## RELINE OF IMPLANT-RETAINED AND TISSUE SUPPORTED OVERDENTURES (CONTINUED)

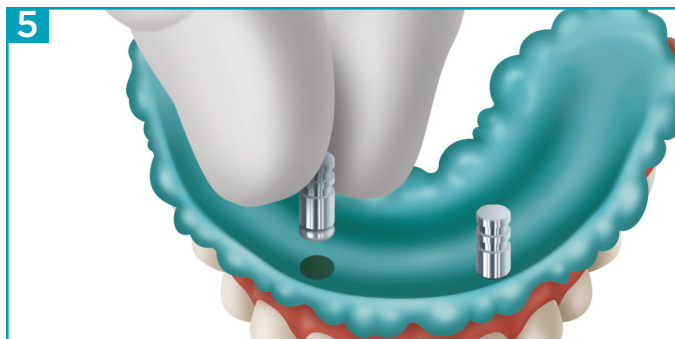

**5** Remove the overdenture from the mouth. The Denture Cap will be picked up in the impression. Press the LOCATOR Analogs into the Black Processing Males. Send the reline impression to the laboratory.



**6** Verify that the Analogs are secure in the Black Processing Males and pour a master cast.



**7** Mount the cast with the overdenture on it in a reline jig.

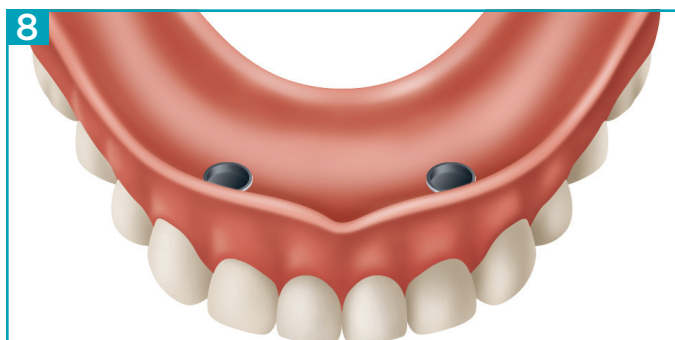

**8** Separate the reline jig and remove the impression material from the overdenture. Process the reline and remove the overdenture from the reline jig. Finish and polish.

# MAINTENANCE OF THE LOCATOR® ABUTMENT

## RELINE OF IMPLANT-RETAINED AND TISSUE SUPPORTED OVERDENTURES (CONTINUED)

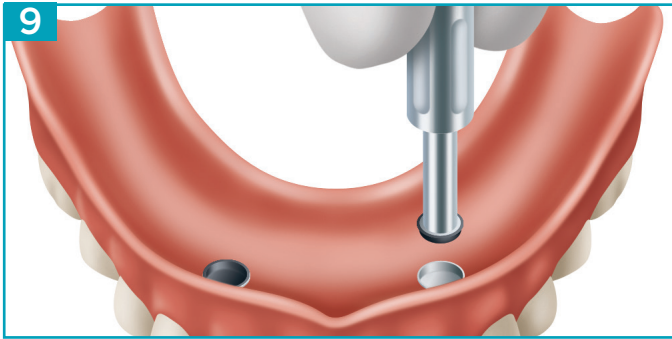

**9** Remove the Black Processing Male using the LOCATOR Core Tool.

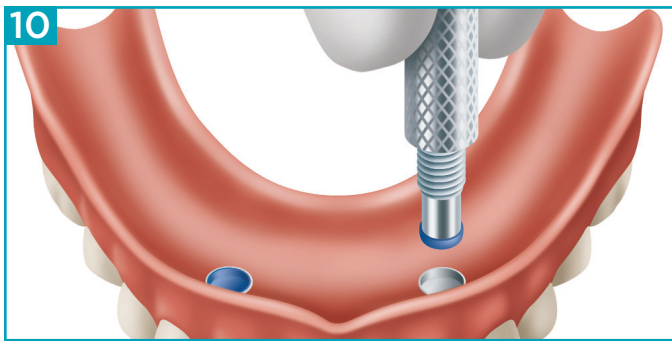

**10** Place the selected final Male into each Denture Cap using the Insertion Tool. Start with the least retentive Male during the initial patient try-in.

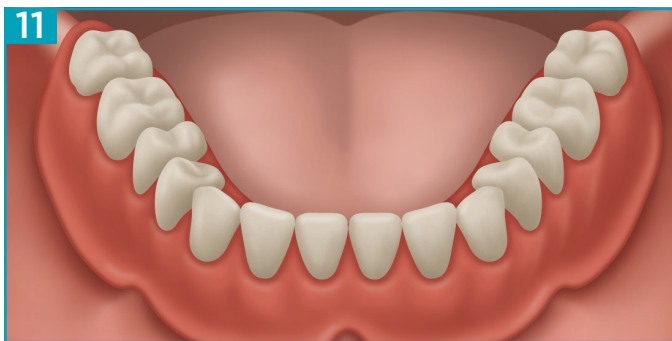

### **11** DELIVERY

Place the overdenture in the mouth and press down to engage the Males on the Abutments. Verify the occlusion. If the retention is not satisfactory, remove the Males and replace with the next level of retention.

**NOTE:** Please refer to the LOCATOR 3-In-1 Core Tool instructions on page 5. Please refer to page 19 for instructions on proper home care maintenance and required recall visits.

# OVERDENTURE INSERTION, REMOVAL AND CLEANING GUIDELINES FOR THE CLINICIAN AND PATIENT

---

To reduce wear on LOCATOR® Abutments, it is critical that clinicians and patients perform routine maintenance on both the LOCATOR Abutment, the Denture Cap and the Retention Male. It is also important that patients understand the proper overdenture maintenance that should be performed at home to guard against retention loss of the Retention Male within the Denture Cap. The following are guidelines to consider:

## INSERTING AND REMOVING AN OVERDENTURE

To insert the overdenture, the patient should ensure he/she can feel that it is properly positioned above the LOCATOR Abutments prior to applying pressure. The patient should use both hands and simultaneously press down on each side to firmly seat the overdenture into place.

The patient should avoid biting the overdenture into place as this force will result in improper wear of the LOCATOR Abutment and may affect the longevity of the prosthesis.

The patient should remove the overdenture by placing one finger under the left edge and one under the right edge of the overdenture and pull one side upward at a time. Once the overdenture is removed a thorough cleaning is recommended.

## CLEANING AN OVERDENTURE

Maintaining proper hygiene is vital to the success of an overdenture, helping it last longer and function properly. Similar to natural teeth, dental plaque will also form on the surface of an overdenture. If the plaque is not removed it will continue to accumulate. It is for this reason that the overdenture should be taken out for cleaning daily. Patients should follow this one simple step daily for cleaning an overdenture.

- 1 Fill a washing basin with warm water to prevent fracture of the overdenture. Apply non-abrasive toothpaste onto a soft bristle toothbrush and thoroughly clean every surface of the overdenture.

## ADDITIONAL NOTES OF CAUTION

Failure of the patient to follow oral hygiene protocols and appropriately care for the overdenture may also result in inflamed tissue around the implant, leading to the development of peri-implantitis. Throughout time, peri-implantitis may cause the implant to become mobile and fail. Please ask patients to consider the following when caring for their overdentures:

- Avoid using abrasive toothpaste to clean the overdenture. The coarse particles in the toothpaste may scratch the surfaces of the overdenture, enhancing the potential for plaque accumulation.
- Chewing tobacco may get caught in the Males and scratch the Abutments, considerably reducing the life of the Abutments, retentive features of the Males and ultimately may affect the dental implants.
- Do not soak the overdenture in bleach or any other products not designed for use with denture cleaning as these can harm the retentive feature of the Male, which may ultimately cause additional wear on the Abutment.
- If a denture cleaning solution such as Polident® or Efferdent® is used, it is recommended that the overdenture be soaked for **fifteen minutes or less**.
- Instruct patients to brush LOCATOR Abutments with a soft-bristled toothbrush and visit the dentist for regular inspection and maintenance of the Abutments, Males and Denture Caps.
- Refrain from picking at the Abutments with toothpicks or other foreign objects.
- Refrain from eating without the overdenture in place as food will scratch the Abutment and may result in failure of the dental implant.
- Oral rinse such as Listerine® mouthwash can be used safely without any negative effect on the Abutments or Replacement Males.
- Do not wash the overdenture in the dishwasher.

# RETURN POLICY AND WARRANTY

---

## ORDERING

Orders are accepted by internet, email, mail, fax, or phone. Regular business hours are 5:00am to 5:00pm PST (Pacific Standard Time). Domestic orders received by 1:00pm PST can be shipped by ground the same day. Orders received by 3:00pm PST can be shipped by express. Institutional orders require a purchase order number.

## PRICING

Zest Dental Solutions® makes every effort to maintain a competitive pricing structure. Pricing is subject to routine review and change without prior notice. All prices listed are in U.S. dollars.

## TERMS AND BILLING

- A. Credit Card:** Payment at the time of order with VISA, AMERICAN EXPRESS, DISCOVER or MASTERCARD is necessary for customers not approved for open account billing or special financing offers.
- B. C.O.D.:** Delivery can also be made by C.O.D. freight collect.
- C. Open Account:** An open account can be established by completing a credit application and receiving approval by Zest Dental Solutions. The terms of orders purchased under open accounts are net 30 days.
- D. Export Orders:** Individual orders shipped outside the U.S. require payment in advance or a letter of credit.
- E. Past Due Accounts:** Past due balances will be subject to a 1.5% finance charge per month, amount equal to 18% per annum.

## SHIPPING CHARGES

Merchandise is shipped prepaid by Zest Dental Solutions with the cost added to the invoice, or freight collect with C.O.D. fee included in the case of C.O.D. shipments. Delivery options include Fed Ex ground, 3-day, 2-day, or overnight rush service.

## LIMITED WARRANTY

Zest Dental Solutions provides a limited warranty for its products, to the original purchaser, to be free from defects in workmanship and materials under normal use and service, for a period of one year from the date

of purchase. Zest Dental Solutions will, at its option, substitute the returned product that proves defective within the warranty period, with a similar product, free of charge.

Zest Dental Solutions continually strives to improve its products, and therefore, reserves the right to improve, modify, or discontinue products at any time without notice or incurring obligations. Purchaser assumes all risks and liability resulting from the use of Zest Dental Solutions Products, whether used separately or in combination with other products not of Zest Dental Solutions manufacture.

## RETURN POLICY

Please Observe the Following Guidelines:

- A.** Authorization for returns must be received from Zest Dental Solutions prior to the return of any product. A Return Material Authorization (RMA) number will be provided for all returns.
- B.** Shipping charges must be prepaid by the customer to accept a return shipment.
- C.** Returned products are subject to a \$20 restocking fee for orders under \$400. For orders \$400 to \$1,000, a \$40 restocking fee will be applied. For orders exceeding \$1,000, please contact your Customer Service Representative for the restocking fee.
- D.** Returned merchandise will be accepted within 90 days of purchase if product is in saleable condition (in its original unopened package and not marred by any added writing or over-labeling).
- E.** Returns will not be accepted after 90 days of purchase.
- F.** Non-returnable items include:
  - 1. Merchandise retained beyond expiration date noted on the package.
  - 2. Packages with broken seals or missing parts
  - 3. Used, damaged, or obsolete products will not be accepted for return.



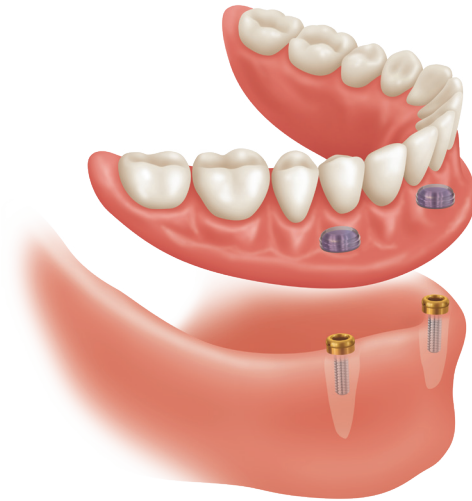

VISIT  
**ZESTDENT.COM**  
24 HOURS A DAY | 7 DAYS A WEEK  
TO PLACE ORDERS ONLINE OR TO FIND THE LATEST  
SUPPORT TOOLS FOR LOCATOR®



**ZEST DENTAL SOLUTIONS**  
2875 LOKER AVENUE EAST  
CARLSBAD, CA 92010 USA  
**WWW.ZESTDENT.COM**

TOLL FREE: 1.800.262.2310  
DIRECT: 1.442.244.4835  
FAX: 760.743.7975  
EMAIL: SALES@ZESTDENT.COM

DISTRIBUTED BY: